











str/nds

S 40

			50Hz	60Hz
				Ø 40 mm
	190 mm		2,20 kW	2,60 kW
	M24 / M28			
	MK 4			
	500 x 400 mm			



330

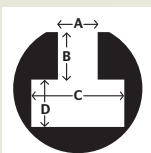

A 14,5 +/- 0,8 mm
 B 13 mm
 C 26 mm
 D 12 mm

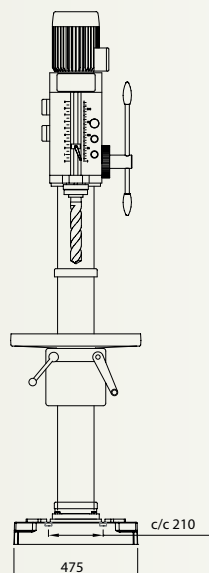
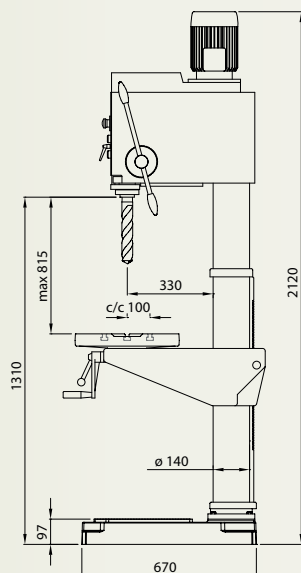

MSC 
**Machinery
 Scandinavia**



T35000



T25003



T40001



T40005



T30006

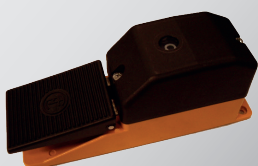

T40010



T40013



T40030 - 60 - 980 rpm

T40031 - 180 - 3000 rpm



T40014

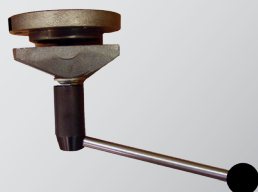

T40021



T40020



T40022

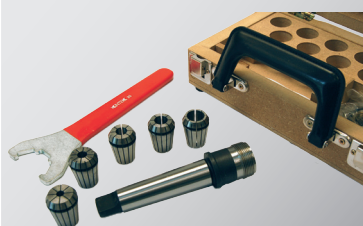

T40042



T40040 0-13 mm

T40041 3-16 mm



TFARGO

Std EU

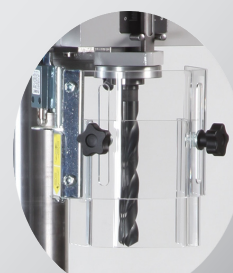

T40051 + T25052



str/nds

S 40 M

	Ø 40 mm		50Hz 90-135 200-300 440-670 980-1500	60Hz 108-162 240-360 528-805 1175-1800
				190 mm
	M24 / M28		mm/r 0,10 0,16 0,24 0,33	inch/r 0,004 0,0064 0,010 0,013
				MK 4
	500 x 400 mm			



340

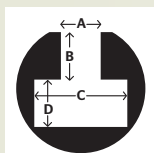

A 14,5 +/- 0,8 mm
 B 13 mm
 C 26 mm
 D 12 mm

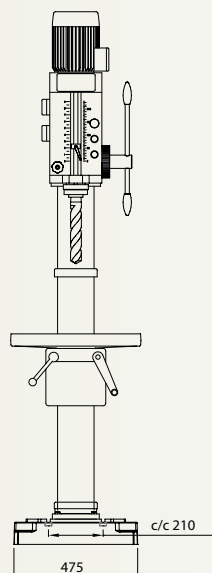
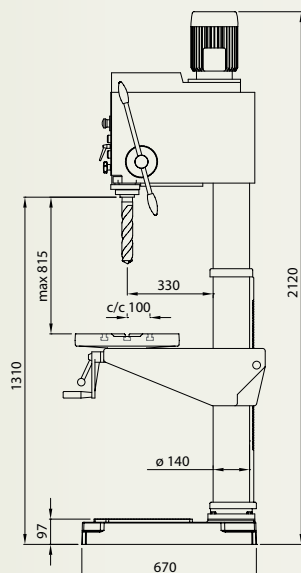

MSC 
**Machinery
 Scandinavia**

Tillbehör S 40 M

Spare parts/Zubehör

strands



T35000



T25003



T40001



T40005



T30006

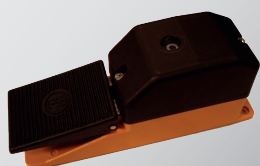

T40010



T40013



T40030 - 60 - 980 rpm

T40031 - 180 - 3000 rpm



T40014

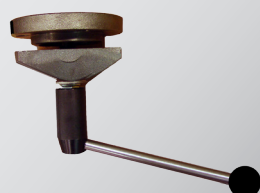

T40021



T40020



T40022

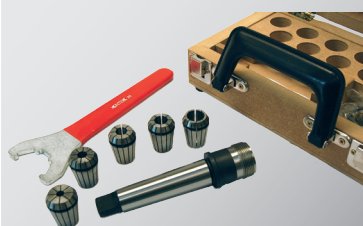

T40042



T40040 0-13 mm

T40041 3-16 mm



TFÄRGO

Std EU

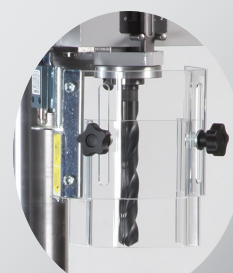

T40051 + T25052

MSC 
**Machinery
Scandinavia**

Machinery Scandinavia AB
570 83 Rosenfors, Sweden
Tel +46 495 49 700
Fax + 46 495 207 30
E-mail: sales@mscab.se
www.strandsmachinery.com



str/nds

S 40 ME

	Ø 40 mm		50Hz 90-135 200-300 440-670 980-1500	60Hz 108-162 240-360 528-805 1175-1800
				190 mm
	M24 / M28		mm/r 0,10 0,16 0,24 0,33	inch/r 0,004 0,0064 0,010 0,013
				MK 4
	500 x 400 mm			



340

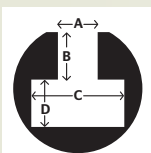

A 14,5 +/- 0,8 mm
 B 13 mm
 C 26 mm
 D 12 mm

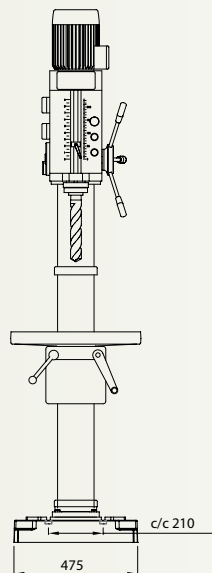
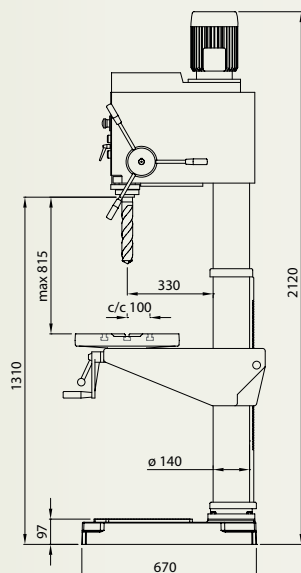

MSC 
Machinery
Scandinavia

Tillbehör S 40 ME

Spare parts/Zubehör

strands



T35000



T25003



T40005



T30006

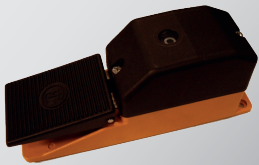

T40010



T40013



T40030 - 60 - 980 rpm

T40031 - 180 - 3000 rpm



T40014

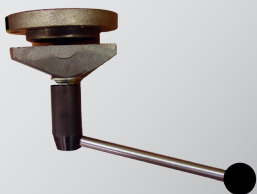

T40021

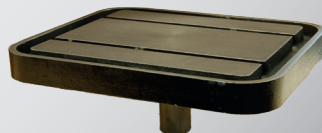

T40020



T40022

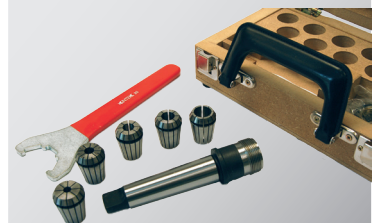

T40042



T40040 0-13 mm



T40041 3-16 mm

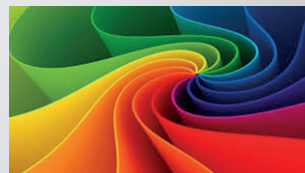

TFARGO

Std EU

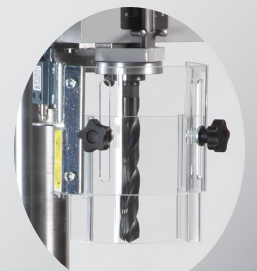

T40051 + T25052

MSC 
**Machinery
 Scandinavia**

Machinery Scandinavia AB
 570 83 Rosenfors, Sweden
 Tel +46 495 49 700
 Fax + 46 495 207 30
 E-mail: sales@mscab.se
www.strandsmachinery.com