

www.geka.es

- World leader in punching and shearing solutions
- Worldwide distribution network
- Proven quality, design and craftsmanship
- Continuous innovation
- Complete after sales service
- Great versatility that includes the highest range in accessories and optional equipments in the market
- The only machine fully produced and manufactured in the European Union
- All GEKA machines are special order. GEKA is the only ironworker that you can customize to fit your needs

www.geka.es

Distributor

Hydracrop models

Where production requires twin operator machines, higher speeds or greater capacity, **GEKA** provides the solution with the **HYDRACROP** range with five working stations: punching, notching, shearing of flat bars, angles and \emptyset and \square bars.



	HYDRACROP 55	HYDRACROP 80	HYDRACROP 110	HYDRACROP 165	HYDRACROP 220
SHEAR FOR FLAT BARS					
Shearing capacity	300x15 / 200x20 mm	450x15 / 300x20 mm	600x15 / 400x20 mm	750x20 / 400x30 mm	750x20 / 400x30 mm
Length of blades	305 mm	475 mm	605 mm	765 mm	765 mm
Working height	880 mm	850 mm	960 mm	870 mm	870 mm
SHEAR FOR SECTION IRON					
Shearing capacity	1100 Kn	1500 Kn	1800 Kn	3000 Kn	3000 Kn
L at 90 °	120x120x10	130x130x13	152x152x13	205x205x18	205x205x18
L at 45	70x70x7	70x70x7	70x70x7	70x70x7	70x70x7
SHEAR FOR BARS					
Round bar \emptyset	40 mm	45 mm	50 mm	60 mm	60 mm
Square bar \square	40 mm	45 mm	50 mm	60 mm	60 mm
WITH SPECIAL BLADES					
UPN Profiles	120 mm	140 mm	160 mm	180 mm	180 mm
IPN Profiles	120 mm	140 mm	160 mm	180 mm	180 mm
NOTCHING					
Plate thickness	10 mm	12 mm	13 mm	16 mm	16 mm
Depth	90 mm	90 mm	90 mm	110 mm	110 mm
Width	42 mm	52 mm	52 mm	58 mm	58 mm
PUNCHING					
Punching power	550 Kn	800 Kn	1100 Kn	1650 Kn	2200 Kn
Maximun capacity with quick change and die with gooseneck die holder	\emptyset 40x10 \emptyset 20x20	\emptyset 40x14 \emptyset 24x24	\emptyset 40x20 \emptyset 28x28	\emptyset 40x30 \emptyset 34x34	\emptyset 40x40

Punching station

The punching station is fitted with an independent cylinder that creates a large, flexible, universal workstation easily adaptable for mounting special tools and "die sets".

-  Cylinder support
-  Split double acting cylinder
-  Limit switches for punch travel setting
-  Generous travel for bending, deep-drawing, forming jobs etc
-  Adjustable generous non-turning guiding
-  Additional guiding for damping of offset forces and protection of hydraulic seals
-  Spindle for fitting of special tools
-  Quick punch change
-  Adjustable material stripper
-  Table with millimetre scales, included in production package
-  Adjustable measuring stop up to 500 mm
-  Gooseneck die-holder for punching channel and section
-  Adjustable bolster locking device X axis
-  Adjustable bolster locking device Y axis
-  Fixing bolt at base of gooseneck

L cutting angle

Fully aware of the importance of distortion free shearing, GEKA has designed a patented system of a floating upper blade that travels along a rectilinear line and is able to shear angles without any deformation and loss of material (single cut); All GEKA Hydracrop models ensure that distortion problems caused by the conventional radial system are now a problem of the past.

-  Adjustable Support
-  Blade gap adjustment screws
-  Upper shear blade without deformation
-  Upper shear blade guides
-  Safety protection

Shearing for flat bars

The excellent stability of the monoblock blade-holder, which is controlled at the each end, makes it possible to mount a long upper blade with a proven geometry to obtain optimum shearing quality. The radial system allows a generous cutting capacity as a result of the force multiplier effect.



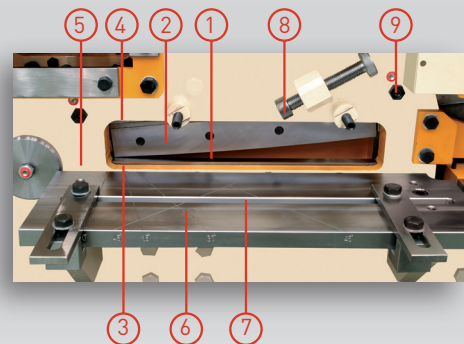



1. Lower blade
2. Upper blade with special geometry
3. Clearance control between shear blades
4. Supplement shearing angle control of upper blade, for shearing without deformation.
5. Adjustable guides 45° right and left.
6. Flat plate/bar shearing table.
7. Slotted guide positioning with coverage of the entire blade length
8. Guide fixing screw
9. Clearance control of blade-holder



Notching station



This station of the machine has been designed to mount several optional accessories, all of which are normally held in stock.

- Triangular notching at 90°
- Tube notching equipment
- Notching of footings

-  Rectangular punch
-  Material stripper
-  Cross centring bolts
-  Fixing holes special tooling
-  Rectangular notching
-  Table with scaled measuring stops, included in production kit

Cutting of Ø and ▧ bars

The GEKA HYDRACROP machines are fitted as standard with blades for cutting Ø and ▧ bars. Furthermore, this station has been designed bearing in mind the shearing of other sections such as L, I, Z for which a large stock of blades is available.

-  Adjusting bolt and height setting of the guide
-  Blade holding flanges
-  Guide fixing bolts